

POWER

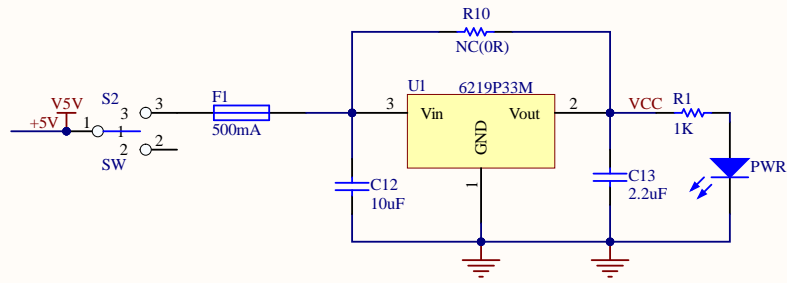

LED

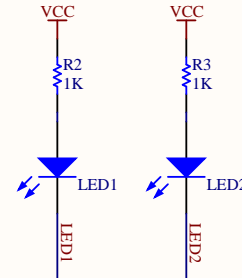
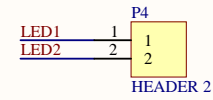

USB

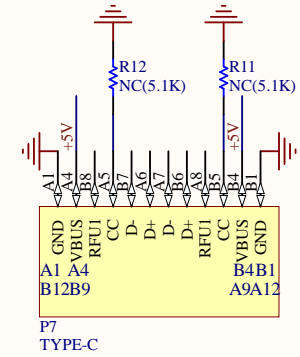

MCU

CH32V003F4P6_MINI

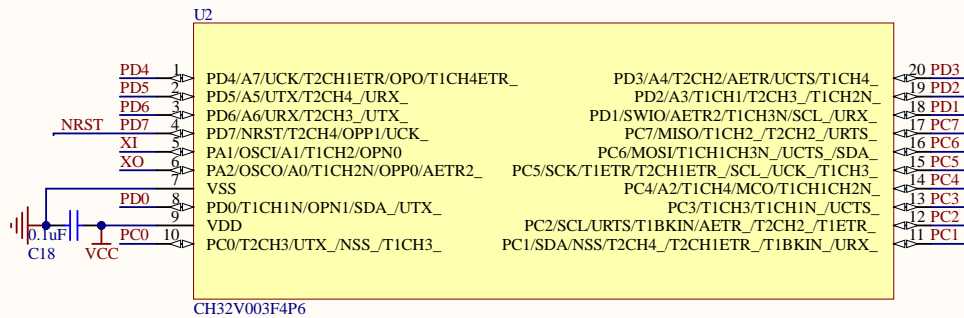

VCC-Support 5Vand3.3V

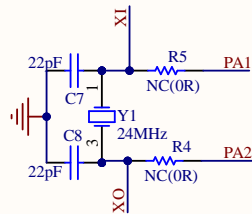

PIN

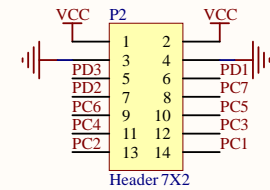
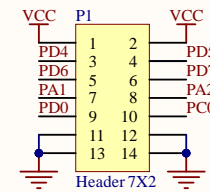

RST

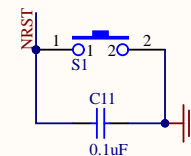

OPA

